



# User Manual

## Envertech Corporation Ltd.

Tel: +86 21 6858 0086

Web: [www.envertec.com](http://www.envertec.com)

Email: [info@envertec.com](mailto:info@envertec.com)

Address: No.138, Xinjunhuan road, Minhang District, Shanghai, China

# Content

1.	<b>Important Safety Information</b> .....	<b>1</b>
1.1	Read It First .....	1
1.2	Safety Instructions .....	1
2.	<b>Envertech Microinverter System</b> .....	<b>2</b>
2.1	How it Works .....	4
2.2	Monitoring Device EnverBridge.....	5
2.3	Optimal Reliability .....	5
2.4	Simple Design.....	5
3.	<b>Product Information</b> .....	<b>5</b>
3.1	Overview .....	5
3.2	Datasheet.....	7
4.	<b>Preparation</b> .....	<b>12</b>
4.1	Packing Checklist.....	12
4.2	Further Information .....	12
4.3	Symbols on Inverter .....	13
4.4	Accessories.....	14
5.	<b>Microinverter System Installation</b> .....	<b>15</b>
6.	<b>Debugging and Operating</b> .....	<b>30</b>
6.1	Energize the System.....	30
6.2	Microinverter Operation .....	31
7.	<b>Troubleshooting and Maintenance</b> .....	<b>31</b>
7.1	LED Status Indications and Error Reporting .....	31
7.2	Troubleshoot an Inoperable Microinverter.....	32
7.3	Disconnect Microinverters from PV Modules .....	33
8.	<b>System Diagram</b> .....	<b>34</b>
9.	<b>Recycling and Disposal</b> .....	<b>38</b>
10.	<b>Contact</b> .....	<b>38</b>

## 1. Important Safety Information

### 1.1 Read it First

This manual contains important instructions for the installation and maintenance of the microinverter.

To reduce the risk of electrical shock, and to ensure safe installation and operation of the microinverter, the following safety symbols appear throughout this document to indicate dangerous conditions and important safety instructions.



#### DANGER

**DANGER** indicates a hazardous situation which, if not avoided, will result in death or serious injury.



#### WARNING

**WARNING** indicates a hazardous situation which, if not avoided, can result in death or serious injury or moderate injury.



#### NOTICE

**NOTICE** indicates a situation that can result in property damage, if not avoided.

### 1.2 Safety Instructions

- Do not use Envertech equipment in a manner not specified by the manufacturer. Doing so may cause death or injury to persons or damage to equipment.
- Be aware that only qualified personnel should install or replace the Envertech microinverters and the cables and accessories.
- Do not attempt to repair the Envertech microinverter; it contains no user-serviceable parts. If it fails, contact Envertech customer service to start the

replacement process. Tampering with or opening the Envertech microinverter will void the warranty.

- If the AC cable on the microinverter is damaged or broken, do not install the unit.
- Before installing or using the Envertech microinverter, read all instructions and cautionary markings in the technical description and on the Envertech microinverter system and the PV equipment.
- Connect the Envertech microinverter to the utility grid only after you have completed all installation procedures and received approval from the electric utility company.
- Please be kindly note that the Envertech microinverter itself is a heat sink. Under normal operating conditions, its temperature is 20°C above ambient, but under extreme conditions, the microinverter can reach a temperature of 90°C.
- Do not disconnect the PV module from the Envertech microinverter without rusty disconnecting AC power.

## 2. Envertech Monitoring system

The Envertech microinverter system is an on-grid microinverter system with world-top-class technology. This manual gives details about how to setup the whole monitoring system with Envertech microinverter.

The three key elements of an Envertech microinverter system include:

EnverBridge, EnverView App and EnvertecPortal.

- EnverBridge (Optional): monitoring and protecting PV system.



- EnverPortal: <http://www.envertechportal.com>

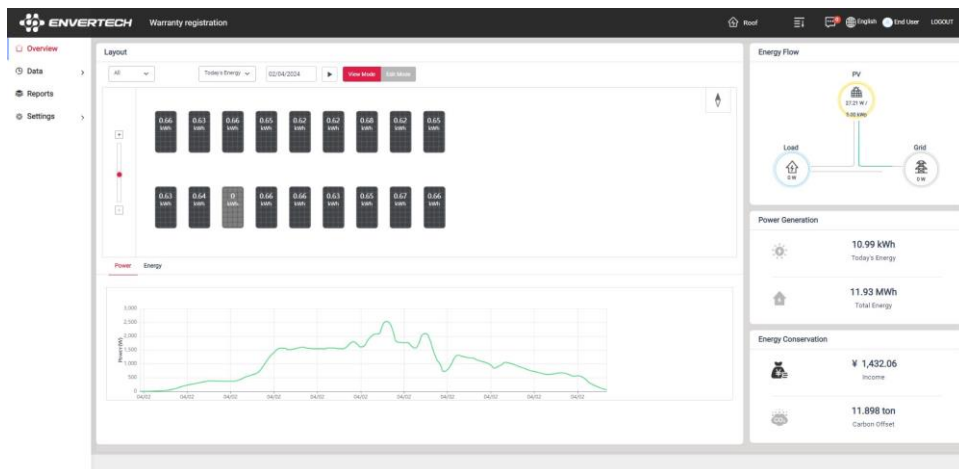

- EnverView: IOS, Android App

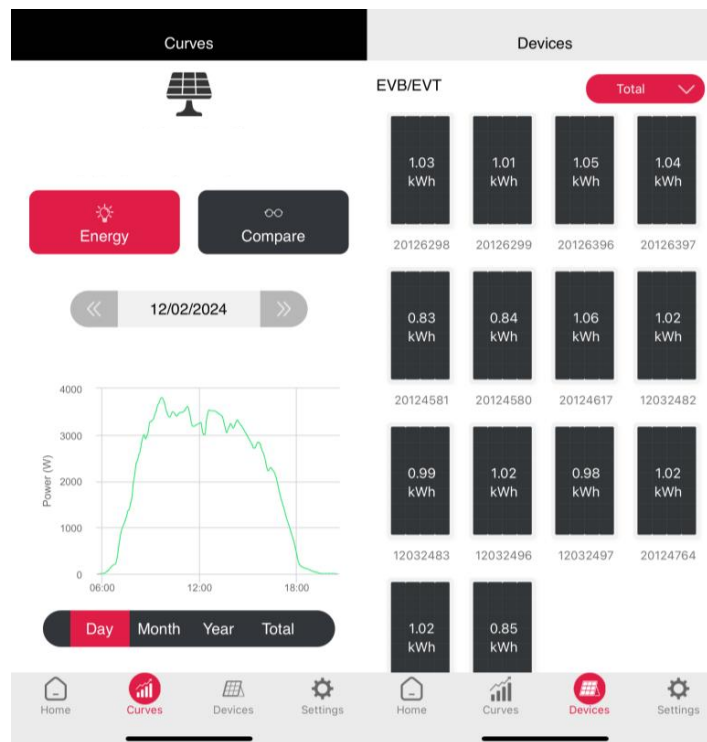

You can view the real-time data from a web browser or EnverView app.

This integrated solar system maximizes energy harvest and increases system reliability. Simplifies design, installation and management.

### 2.1 How it Works

The Envertech microinverter maximizes energy production from your photovoltaic (PV) array. Each Envertech microinverter is individually connected to one PV module in your array. This unique conjunction means that an individual Maximum Peak Power Point Tracker (MPPT) controls each PV module. This ensures that the maximum power available from each PV module is exported to the utility grid regardless of the performance of the other PV modules in the array. That is, although individual PV modules in the array may be acted by shading, soiling, orientation, or PV module mismatch, the



Envertech microinverter ensures top performance for its associated PV module. The result is maximum energy production from your PV system.

## 2.2 Monitoring Device: EnverBridge

Once you install EnverBridge and have it connected to your broadband router or modem, Envertech microinverters automatically begin to report to EnverBridge's server. EnverBridge monitoring system presents both real-time and historical performance data.

## 2.3 Optimal Reliability

Microinverter systems are inherently more reliable than traditional inverters. The distributed nature of a microinverter system ensures that there is no single-point failure in the PV system. Envertech Microinverters are designed to operate at full power at ambient temperatures as high as +65°C (150 °F). The microinverter casing is designed for outdoor installation and complies with the IP67 protection level.

**Note:** To ensure optimal reliability and to meet warranty requirements, the microinverter must be installed according to the instructions in this manual.

## 2.4 Simple Design

PV systems using Envertech microinverters are very simple to design and install. You can install a combination of PV modules of any type, at any orientation, and in any quantity. You won't need to install cumbersome traditional inverters. Each microinverter can be quickly mounted on the PV rack, directly beneath each PV module. Low-voltage DC wires connect from the PV module directly to the co-located microinverter, eliminating the risk of personnel exposure to dangerously high DC voltage.

## 3. Product Information

**Note:** For optimum reliability and to comply with warranty conditions, the microinverter must be installed according to the instructions in this manual.

### 3.1 Major Characteristics

Envertech microinverters have the following characteristics which make Envertech microinverters "Highly Efficient, Highly Reliable, Highly Cost Effective".

Low DC input voltage.

Wide MPPT voltage range ensures high yield under various weather conditions. High MPPT accuracy ensures minimum power loss during converting. Complete set of protective functions.

Also, the following protective functions are integrated into Envertech microinverters. Internal overvoltage/undervoltage protection

Faulty grounding protection Grid monitoring.

Current monitoring in grounding DC monitoring.

Microinverter can be adapted to almost all modules. Before installation, please check the parameters of the microinverters and modules to ensure that they are compatible.

### CE Statement

Envertech (Shanghai) Corporation Ltd. declares that this microinverter (Wi-Fi integrated) complies with the essential requirements and other relevant provisions of Directive 2014/53/EU. Following Article 10(2) and Article 10(10), this product is allowed to be used in all EU member states.

### Safe Distance Warning

Use the microinverter (Wi-Fi integrated) in an environment with a temperature between -40°C and 65°C, The device complies with RF specifications when the device is used at 20 cm from your body.

### Operation Frequency (Only for products with built-in Wi-Fi module)

Wi-Fi: 2.4G

Frequency: 2412MHz-2472MHz

Output Power: 802.11 b/g/n:<19dBm (e.i.r.p)

### Bluetooth Low Energy (Only for products with Bluetooth function)

Frequency: 2402MHz-2480MHz, Max e.i.r.p <2dBm

3.2 Datasheet

Model	EVT300	EVT350	EVT360
<b>Input Data (DC)</b>			
Recommended Module Power Range (W)	180W~450W+	180W~550W+	180W ~ 500W+
Maximum Input Voltage (V)	54	60	60
Minimum Start Voltage (V)	18	16	16
Maximum Continuous Input Current (A)		12	
Maximum Input Short Circuit Current (A)		25	
Number of MPPT		1	
<b>Output Data (AC)</b>			
Maximum Continuous Output Power (VA)	330	350	360
Maximum Continuous Output Current (A)	1.51	1.594	1.64
Nominal Output Voltage/Range (V)	220/230/ (189-260)		
Nominal Frequency/Range (Hz)	50Hz (47.5-52.5Hz) 60Hz (57.5-62.5Hz)		
Power Factor(Adjustable)	+/-0.90		
Total Harmonic Distortion	<3%		
Maximum Units Per 12AWG Branch (Units)	17	15	15
<b>Efficiency</b>			
Peak Efficiency (%)	95.50%	96.30%	95.50%
MPPT Efficiency (%)	99.90%		
Nighttime Power Consumption (mW)	<100		
<b>Features</b>			
Communication	PLCC (Power Line Carrier Communication) / Wi-Fi		
Compliance	IEC/EN 62109-1/-2, IEC/EN 61000-3-2/-3, IEC/EN 61000-6-1/-2/-3/-4, IEC/EN 55014-1/-2, EN 50549- 1 :2019, IEC/EN 62920:2017, VDE-AR-N 4105:2018, TOR 2019, OVE R25:2020, NA/EEA-NE7-CH2022, C10/11 :2019, UTE C15-712-1 :2013, VFR 2019, CEI 0-21 :2019, 2016/631 EU – (NC RfG)		
Inverter Isolation	High Frequency Isolated		
Overvoltage Category	OVC III (AC Main), OVC II (PV)		
Protective Class	Class I		
Warranty	15 Years (20 Years Optional)		
<b>Mechanical and Environment Data</b>			
Ambient Temperature Range (°C)	-40°C to +65°C		
Relative Humidity	0%~98%		
Dimensions (W*H*D) (mm)	163.3*163.7*27	163.3*163.7*27	163.3*163.7*35.5
Weight (kg)	1.8	1.8	1.8
Ingress Protection (IP)	IP 67		
Cooling	Natural convection		

Model	EVT400	EVT500	EVT560
<b>Input Data (DC)</b>			
Recommended Module Power Range (W)	180W ~ 550W+	250W ~ 650W+	(180W ~ 450W+)*2
Maximum Input Voltage (V)	60	60	54
Minimum Start Voltage (V)	16	16	18
Maximum Continuous Input Current (A)	14	18	12*2
Maximum Input Short Circuit Current (A)		25	
Number of MPPT	1	1	2
<b>Output Data (AC)</b>			
Maximum Continuous Output Power (VA)	400	500	600
Maximum Continuous Output Current (A)	1.81	2.27	2.72
Nominal Output Voltage/Range (V)	220/230/ (189-260)		
Nominal Frequency/Range (Hz)	50Hz (47.5-52.5Hz) 60Hz (57.5-62.5Hz)		
Power Factor(Adjustable)	+/-0.90		
Total Harmonic Distortion	<3%		
Maximum Units Per 12AWG Branch (Units)	13	10	8
<b>Efficiency</b>			
Peak Efficiency (%)		96.80%	
MPPT Efficiency (%)	99.90%		
Nighttime Power Consumption (mW)	<100		
<b>Features</b>			
Communication	PLCC (Power Line Carrier Communication) / Wi-Fi		
Compliance	IEC/EN 62109-1/-2, IEC/EN 61000-3-2/-3, IEC/EN 61000-6-1/-2/-3/-4, IEC/EN 55014-1/-2, EN 50549- 1 :2019, IEC/EN 62920:2017, VDE-AR-N 4105:2018, TOR 2019, OVE R25:2020, NA/EEA-NE7-CH2022, C10/11 :2019, UTE C15-712-1 :2013, VFR 2019, CEI 0-21 :2019, 2016/631 EU – (NC RfG)		
Inverter Isolation	High Frequency Isolated		
Overvoltage Category	OVC III (AC Main), OVC II (PV)		
Protective Class	Class I		
Warranty	15 Years (20 Years Optional)		
<b>Mechanical and Environment Data</b>			
Ambient Temperature Range (°C)	-40°C to +65°C		
Relative Humidity	0%~98%		
Dimensions (W*H*D) (mm)	163.3*163.7*35.5	163.3*163.7*35.5	248*169*27.5
Weight (kg)	1.8	1.8	2.8
Ingress Protection (IP)	IP 67		
Cooling	Natural convection		

Model	EVT720	EVT800SE	EVT800
<b>Input Data (DC)</b>			
Recommended Module Power Range (W)	(180W ~ 500W+)*2	(180W ~ 550W+)*2	(180W ~ 550W+)*2
Maximum Input Voltage (V)	60		
Minimum Start Voltage (V)	16		
Maximum Continuous Input Current (A)	12*2	14*2	14*2
Maximum Input Short Circuit Current (A)	25		
Number of MPPT	2		
<b>Output Data (AC)</b>			
Maximum Continuous Output Power (VA)	720	800	800
Maximum Continuous Output Current (A)	3.27	3.64	3.63
Nominal Output Voltage/Range (V)	220/230/ (189-260)		
Nominal Frequency/Range (Hz)	50Hz (47.5-52.5Hz)		
	60Hz (57.5-62.5Hz)		
Power Factor(Adjustable)	+/-0.90		
Total Harmonic Distortion	<3%		
Maximum Units Per 12AWG Branch (Units)	7	6	6
<b>Efficiency</b>			
Peak Efficiency (%)	96.50%		
MPPT Efficiency (%)	99.90%		
Nighttime Power Consumption (mW)	<100		
<b>Features</b>			
Communication	PLCC (Power Line Carrier Communication) / Wi-Fi		
Compliance	IEC/EN 62109-1/-2, IEC/EN 61000-3-2/-3, IEC/EN 61000-6-1/-2/-3/-4, IEC/EN 55014-1/-2, EN 50549-1 :2019, IEC/EN 62920:2017, VDE-AR-N 4105:2018, TOR 2019, OVE R25:2020, NA/EEA-NE7-CH2022, C10/11 :2019, UTE C15-712-1 :2013, VFR 2019, CEI 0-21 :2019, 2016/631 EU – (NC RfG)		
Inverter Isolation	High Frequency Isolated		
Overvoltage Category	OVC III (AC Main), OVC II (PV)		
Protective Class	Class I		
Warranty	15 Years (20 Years Optional)		
<b>Mechanical and Environment Data</b>			
Ambient Temperature Range (°C)	-40°C to +65°C		
Relative Humidity	0%~98%		
Dimensions (W*H*D) (mm)	264*194*35.5	248*236*27.5	264*194*35.5
Weight (kg)	4.1	2.8	4.1
Ingress Protection (IP)	IP 67		
Cooling	Natural convection		

Model	EVT1600SE	EVT1800SE	EVT2000SE
<b>Input Data (DC)</b>			
Recommended Module Power Range (W)	(250W~650W+)*4		
Maximum Input Voltage (V)	60		
Minimum Start Voltage (V)	16		
Maximum Continuous Input Current (A)	20*4		
Maximum Input Short Circuit Current (A)	25		
Number of MPPT	4		
<b>Output Data (AC)</b>			
Maximum Continuous Output Power (VA)	1600	1800	2000
Maximum Continuous Output Current (A)	7.27	8.18	9.09
Nominal Output Voltage/Range (V)	220/230/ (189-260)		
Nominal Frequency/Range (Hz)	50Hz (47.5-52.5Hz)		
	60Hz (57.5-62.5Hz)		
Power Factor(Adjustable)	+/-0.90		
Total Harmonic Distortion	<3%		
Maximum Units Per 12AWG Branch (Units)	3	2	2
Maximum Units Per 10AWG Branch (Units)	4	3	3
<b>Efficiency</b>			
Peak Efficiency (%)	96.50%	96.30%	96.00%
MPPT Efficiency (%)	99.90%		
Nighttime Power Consumption (mW)	<100		
<b>Features</b>			
Communication	PLCC (Power Line Carrier Communication) / Wi-Fi		
Compliance	IEC/EN 62109-1/-2, IEC/EN 61000-3-2/-3, IEC/EN 61000-6-1/-2/-3/-4, IEC/EN 55014-1/-2, EN 50549-1 :2019, IEC/EN 62920:2017, VDE-AR-N 4105:2018, TOR 2019, OVE R25:2020, NA/EEA-NE7-CH2022, C10/11 :2019, UTE C15-712-1 :2013, VFR 2019, CEI 0-21 :2019, 2016/631 EU – (NC RfG)		
Inverter Isolation	High Frequency Isolated		
Overvoltage Category	OVC III (AC Main), OVC II (PV)		
Protective Class	Class I		
Warranty	15 Years (20 Years Optional)		
<b>Mechanical and Environment Data</b>			
Ambient Temperature Range (°C)	-40°C to +65°C		
Relative Humidity	0%~98%		
Dimensions (W*H*D) (mm)	300*199.5*41		
Weight (kg)	4.7		
Ingress Protection (IP)	IP 67		
Cooling	Natural convection		

Model	EVT1000	EVT2000	EVT2500
<b>Input Data (DC)</b>			
Recommended Module Power Range (W)	(250W~650W+)*2 (250W~650W+)*4 (250W~700W+)*4		
Maximum Input Voltage (V)	60		
Minimum Start Voltage (V)	16		
Maximum Continuous Input Current (A)	18*2	18*4	20*4
Maximum Input Short Circuit Current (A)	25		
Number of MPPT	2	4	4
<b>Output Data (AC)</b>			
Maximum Continuous Output Power (VA)	1000	2000	2500
Maximum Continuous Output Current (A)	4.55	9.09	11.36
Nominal Output Voltage/Range (V)	220/230/ (189-260)		
Nominal Frequency/Range (Hz)	50Hz (47.5-52.5Hz)		
	60Hz (57.5-62.5Hz)		
Power Factor(Adjustable)	+/-0.90		
Total Harmonic Distortion	<3%		
Maximum Units Per 10AWG Branch (Units)		3	3
Maximum Units Per 12AWG Branch (Units)	5	2	2
<b>Efficiency</b>			
Peak Efficiency (%)	96.80%	96.50%	96.50%
MPPT Efficiency (%)	99.90%		
Nighttime Power Consumption (mW)	<100		
<b>Features</b>			
Communication	PLCC(Power Line Carrier Communication)/ Wi-Fi		
Compliance	Same as EVT800	EN / IEC 61000, EN / IEC 62109, EN / IEC 55014, CEI 0-21 PORTARIA No 140, DE 21 DE MARÇO DE 2022, PORTARIA Nº 515, DE 10 DE NOVEMBRO DE 2023	
Inverter Isolation	High Frequency Isolated		
Overvoltage Category	OVC III (AC Main), OVC II (PV)		
Protective Class	Class I		
Warranty	15 Years (20 Years Optional)		
<b>Mechanical and Environment Data</b>			
Ambient Temperature Range (°C)	-40°C to +65°C		
Relative Humidity	0%~98%		
Dimensions (W*H*D) (mm)	264*194*35.5	395*242.4*47	395*242.4*47
Weight (kg)	4.1	6.5	6.5
Ingress Protection (IP)	IP 67		
Cooling	Natural convection		

## 4. Preparation

### 4.1 Packing Checklist

After you receive the Envertech microinverter, please check if there is any damage on the carton, and then check the inside completeness for any visible external damage on the microinverter and accessories. Contact your dealer if anything is damaged or missing.

Microinverter x1

User Manual x1







\*Antenna for Wi-Fi x1

\*This antenna is for microinverter that has built-in Wi-Fi module.

### 4.2 Further Information







If you have any further questions concerning accessories or installation, please check our website [www.envertec.com](http://www.envertec.com) or send an email to [tech@envertec.com](mailto:tech@envertec.com).

### 4.3 Symbols on Inverter





Symbol	Description
	<b>Dangerous electrical voltage</b> This device is directly connected to the public grid, thus all work related to the inverter shall only be carried out by a qualified person.
	<b>NOTICE, danger!</b> This device is directly connected to electricity generators and the public grid.
	<b>Danger of hot surface</b> The components inside the inverter will release a lot of heat during operation. DO NOT touch aluminum casing during operating
	<b>An error has occurred</b> Please go to Chapter 7 "Trouble Shooting" to repair the error.
	This device SHALL NOT be disposed of in residential waste. Please go to Chapter 9 "Recycling and Disposal" for proper treatments.
	<b>No unauthorized perforations or modifications</b> Any unauthorized perforations or modifications are strictly forbidden. If any defect or damage (device/person) is occurred, Envertech shall not take any responsibility for it.

### 4.4 Accessories

#### For microinverter with BC05 connector

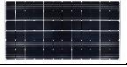
PV Module	Module	
AC Extension Cable	Connect multiple microinverters in the system.	
T-Connector	For connecting the microinverter's AC connector to the trunk connector.	
Trunk Cable with Trunk Connector	Connect T-connectors	
End Cap	Male End Cap	
Microinverter Disconnecter	For disconnecting the microinverter AC connector, trunk male and female connectors from the T-connector.	

#### For microinverter with BC01 connector

PV Module	Module	
AC Extension Cable	To connect the AC side to the grid.	
AC End Cap	To seal the end of unused AC cable.	
AC Connector	Connect the microinverter's AC side to the extension cable.	

## 5. Microinverter System Installation



### WARNING

Only qualified personnel may connect the Envertech microinverter to the utility grid after receiving prior approval from the electrical utility company.

Installing Envertech microinverter system involves several key steps. Each step listed here is elaborated on the following pages.

#### Step 1. Verify voltage

#### Step 2. Mount microinverters onto the rack

#### Step 3. Ground the system

#### Step 4. Install a Wi-Fi antenna

#### Step 5. Fasten AC cables

#### Step 6. Connect to the grid

#### Step 7. Connect PV modules to microinverters

#### Step 8. Switch on the PV system

#### Step 9. Monitoring device (EnverBridge) installation

#### Step 10. Wi-Fi configuration

#### Step 11. Monitoring



### WARNING

You must install the microinverter system under connection neither to the grid nor to the PV modules (or if not disconnected, the modules should be shaded).



### WARNING

Installation could only be implemented when the system is disconnected from the grid, and the solar panel has been covered or disconnected.

#### Step 1. Verify the voltage range

Verify the grid and PV panel voltages are within the microinverter voltage range.

#### Step 2. Mount microinverters

Mark out the estimated center of PV modules on the rack to mount the

microinverter.

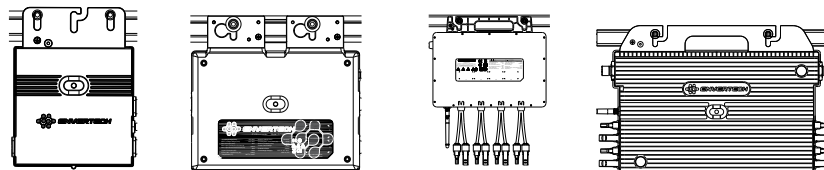

Mount all microinverters under modules to avoid rain and sun. Make sure you can see the LED light.

**Note:** Please strictly follow the relevant content of Maximum Units Per Branch (12AWG Cable) in the datasheet for installation.

#### Step 3. Ground the system

Microinverters and modules must be connected to the ground. Fix the screws to the microinverter installation hole. Make sure that the grounding screw thread is firmly connected the bracket.

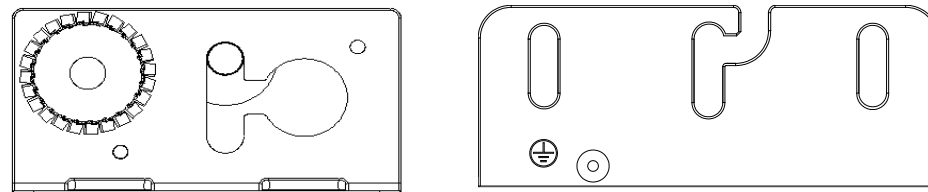

#### Step 4. Install the Wi-Fi antenna

Rotate the antenna clockwise until it is firmly secured to the microinverter.

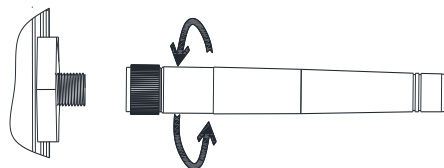

#### Step 5. Fasten AC and DC cables

Fasten AC cables, DC cables and grounding cables to the rack with cable ties. For R version microinverter, insert end cap on unused side.

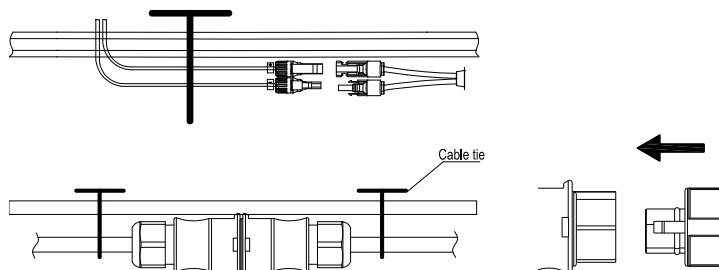

Insert the end cap directly into the unused end connector and make sure it is inserted in place. (For EVT2500)

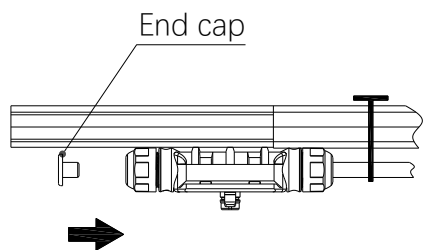

**Step 6. Connect to the grid**

(For EVT2500/EVT2000SE)

a. Connect one microinverter in the system

1) Connect the AC connector of the micro-inverter to the female connector of the AC extension cable plug, then insert the plug into the socket.

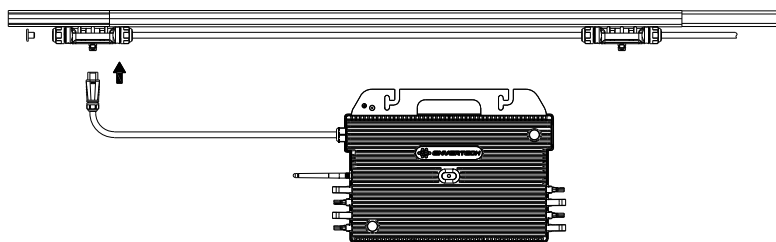

b. Connect multiple microinverters in the system.

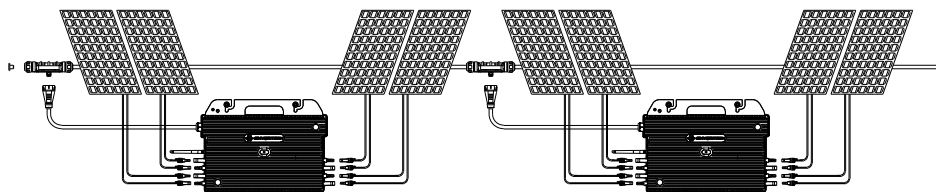

Option a. Connect to air switch (Please refer to Chapter 8 for installation system diagram)

a. Remove the skin of the two ends of the extension cable by  $y=40\text{mm}$  and

remove the skin of internal wires by  $x=14\text{mm}$ . Set the metal terminals onto the open parts and clamp them to tighten the connection;

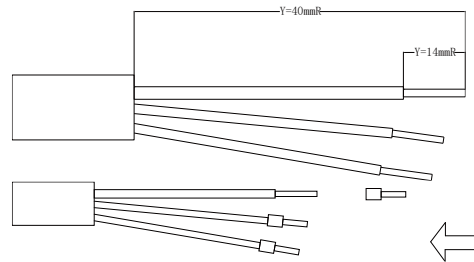

b. Connect the other side of the extension cable to the air switch.

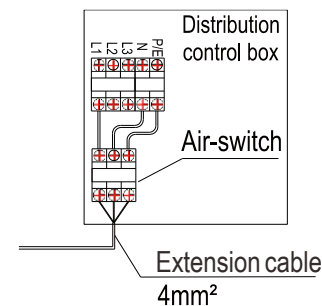

Option b. Put the open parts of the extension cable into the plug and use the plug to connect to the socket (For B version microinverter)

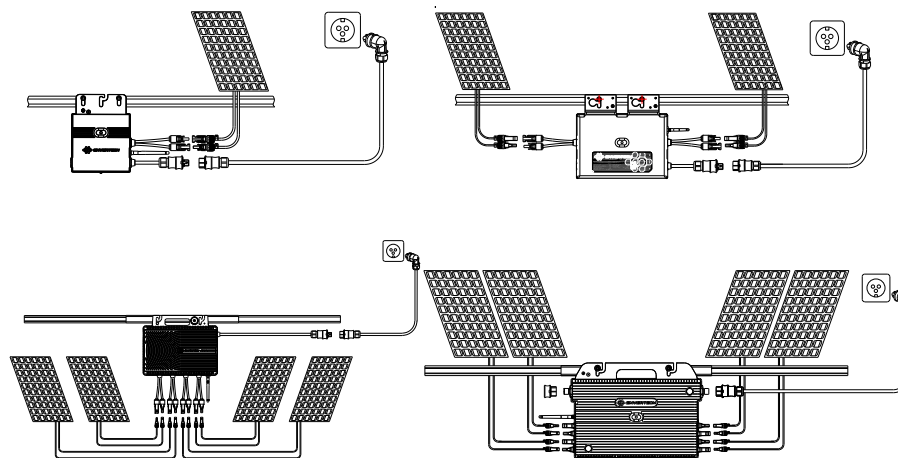

**Step 7. Connect PV modules to microinverters**

Mount the PV modules on top of the microinverters; Connect each PV module with the DC input cables of the microinverter.

Note: Please position the microinverter as close as possible to the router.

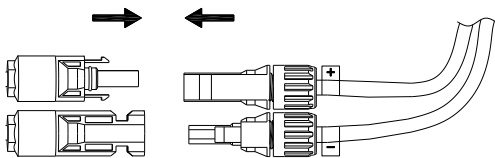

**Step 8. Switch on the PV system**

Ensure all connection is completed. Turn on the air switch. In a short time, you shall see the signal light blinking in green.

**Step 9. (Optional) For the monitoring device (EnverBridge) installation, scan this QR code**

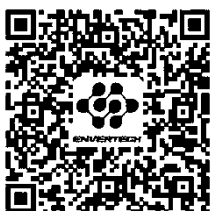

**EnverBridge Installation**

**Step 10. Wi-Fi configuration (For microinverter that has built-in Wi-Fi module. The SN after CN2310.)**

Option 1. Use Bluetooth to configure Wi-Fi

**Note: Please position the microinverter as close as possible to the router.**



**Note: Turn on Bluetooth, Wi-Fi and location services in your phone before you start.**

a. Open EnverView and click **WIFI**. Select **Bluetooth**. Select the same Wi-Fi name as the EVT SN.

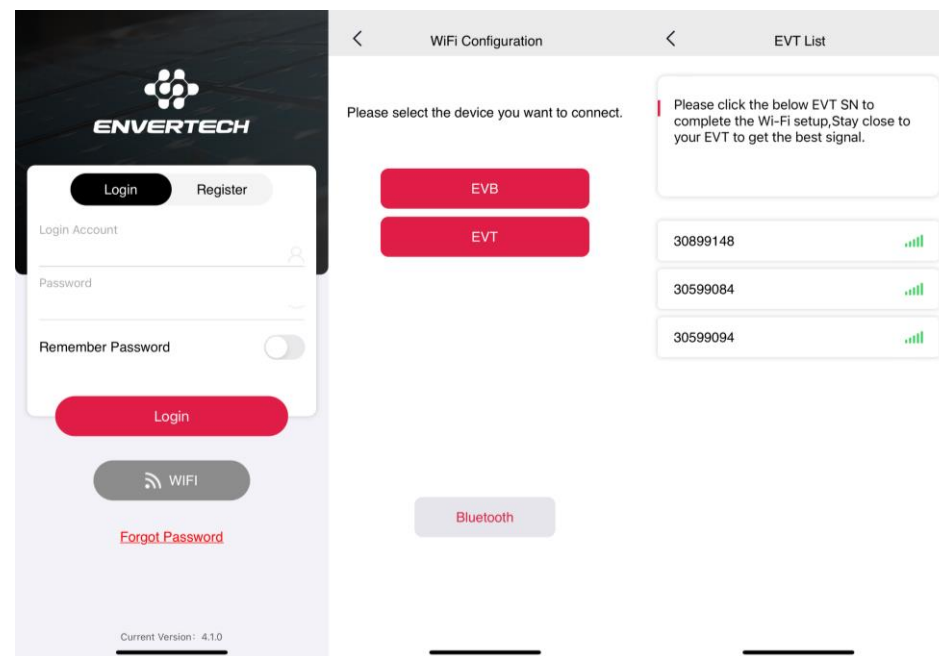

b. Select a 2.4GHz Wi-Fi network, and return to the app. Enter Wi-Fi password. Allow EnverView to use your location, otherwise you will fail to configure Wi-Fi.



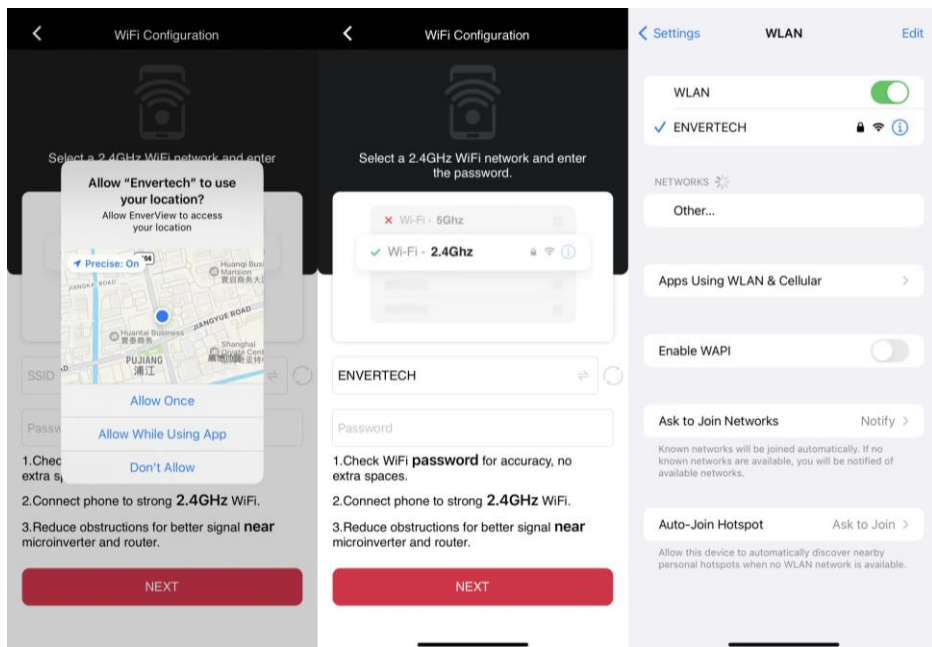

c. Click NEXT and wait for success. Please allow EnverView to access your local network. If not, it will cause configuration failure.

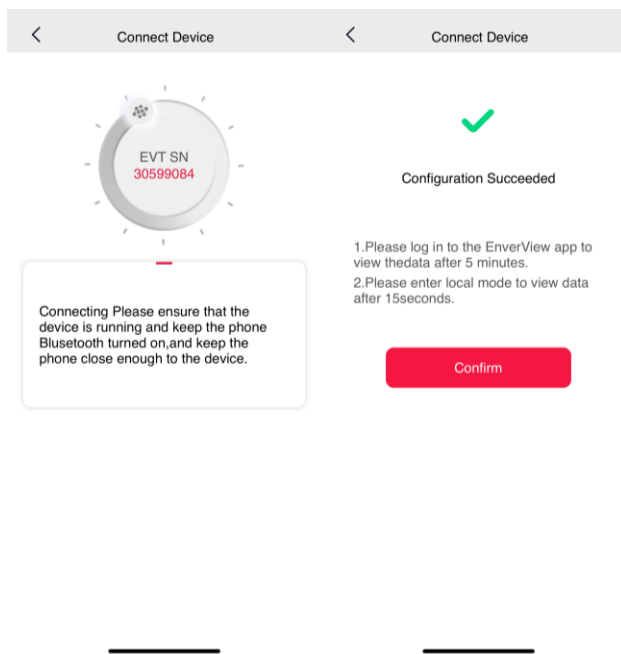

**Note: When configuring Wi-Fi, make sure you keep staying on the current network.**

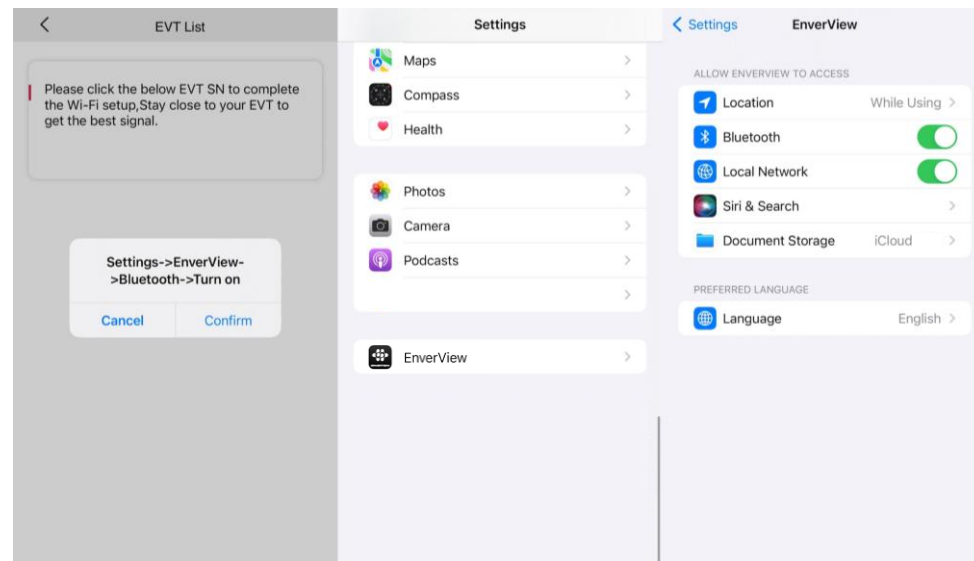

**Note: If the Bluetooth doesn't open successfully. You will receive the above reminders. Please turn on Bluetooth.**

Option 2. Use EVT to configure Wi-Fi

**Note: Please position the microinverter as close as possible to the router.**

The microinverter has built-in Wi-Fi modular and can be connected to the router directly.

Web Portal address: <https://www.envertecportal.com>

Scan the **QR code** below or search for **EnverView** on your app store to download.



EnverView App

a. Open EnverView and click **Wi-Fi**. Select **EVT**.

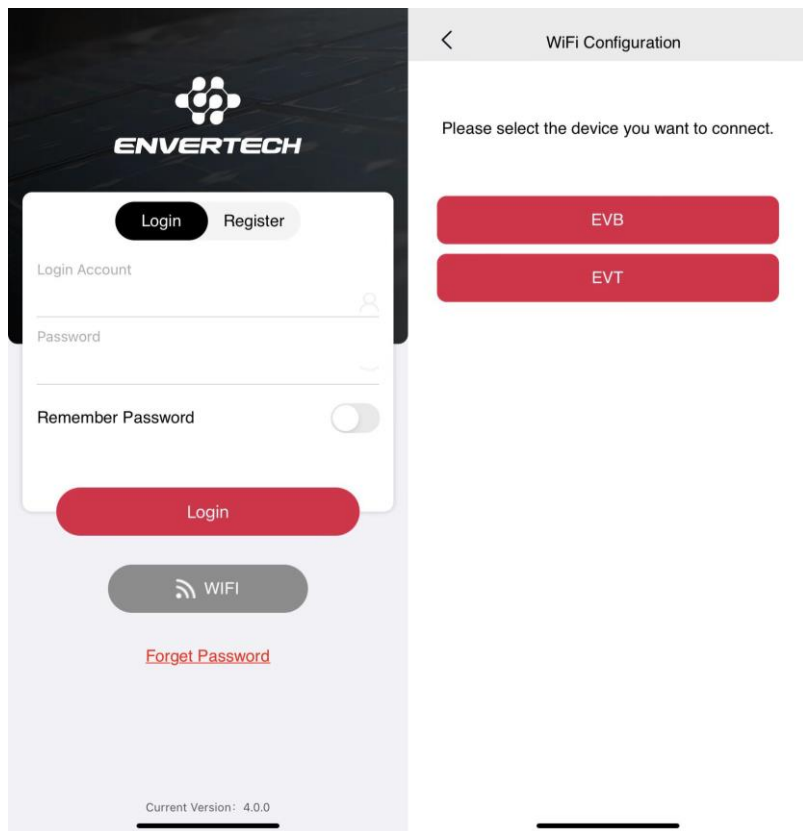

b. Select a 2.4GHz Wi-Fi network, and return to the app. Enter Wi-Fi password. Allow EnverView to use your location, or you will fail to configure Wi-Fi.

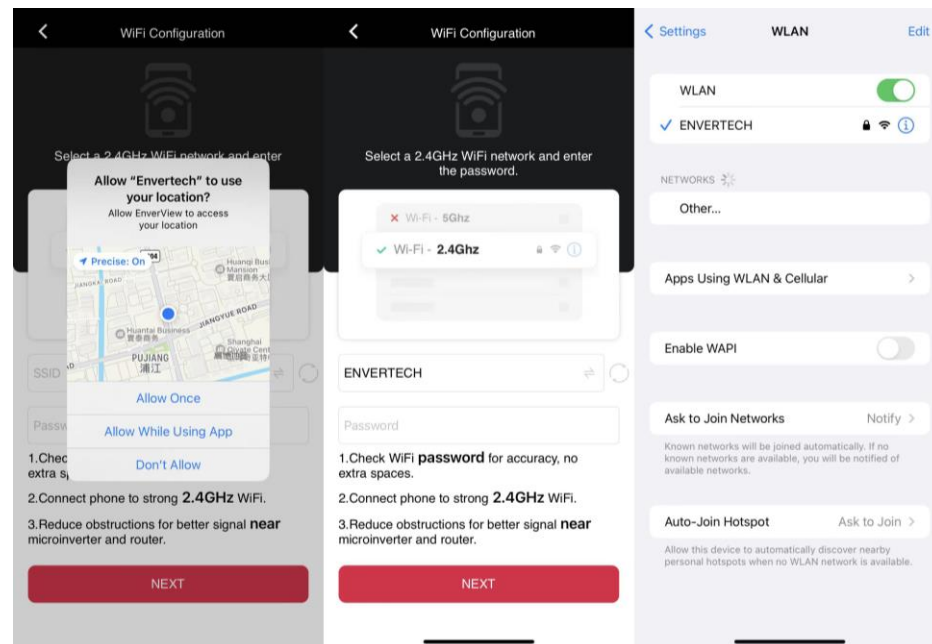

**Note:**

1. Ensure that the Wi-Fi name does not contain , ; = or other special characters.
  2. Check the Wi-Fi password, including spaces and special characters.
  3. Ensure the Wi-Fi your phone connected to is 2.4GHz, and the connection between the router and the Internet is in good condition.
- c. Connect the network of the same name as your EVT’s SN. Return to the app. Allow EnverView to access your local network. If not, it will cause configuration failure.

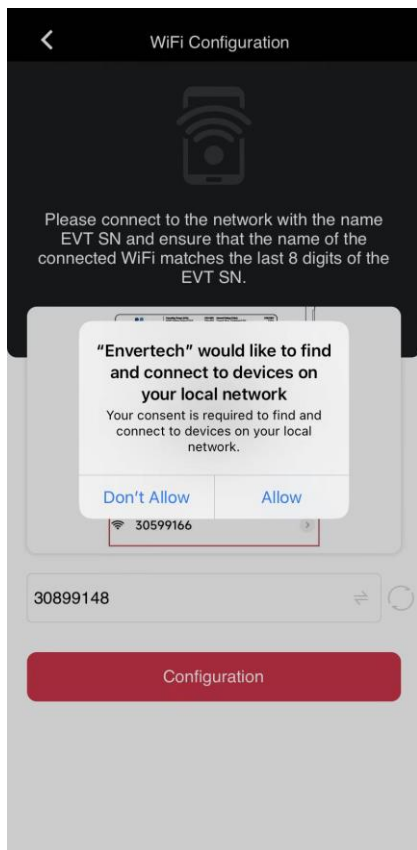

**Note: When configuring Wi-Fi, make sure you keep staying on the current network.**

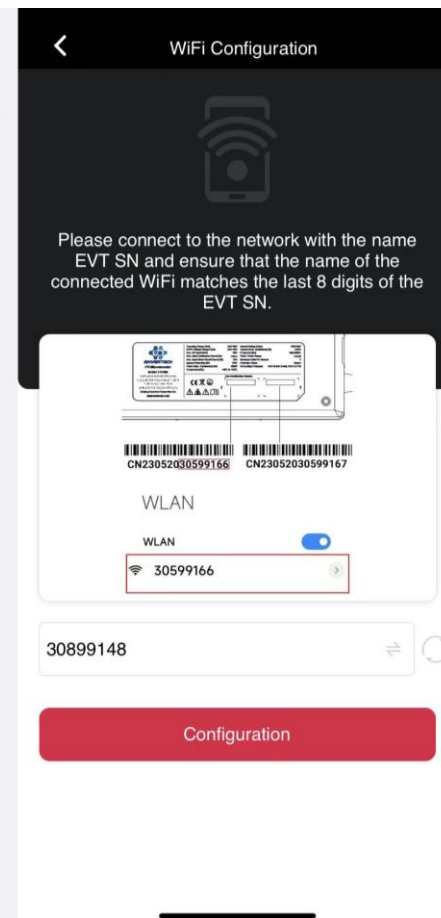
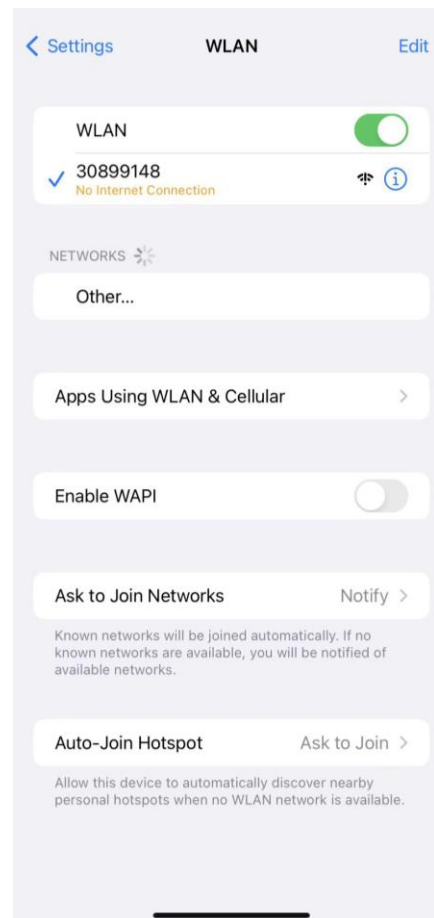

d. Click Configuration and wait for success.

WiFi Configuration



Configuration Succeeded

Please log in to the EnverView app to view the data after 5 minutes  
Please enter local mode to view data after 15 seconds

Confirm

**Note:** If the setting is not successful, wait for 5 more seconds. Click Configuration again and check that the microinverter is as close to the router as possible.

**Step 11. Monitoring**

1) Register a new account by app or website.

**Option 1.** Visit [www.envertecportal.com](http://www.envertecportal.com). Click Register. Fill in the account information to finish registration.

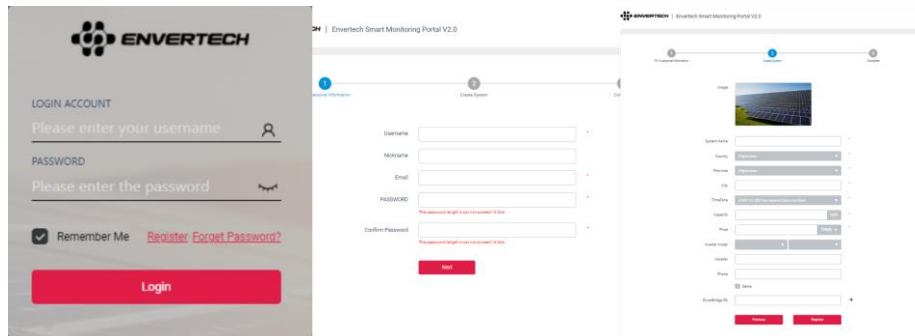

**Option 2.** Use the app “EnverView” to register

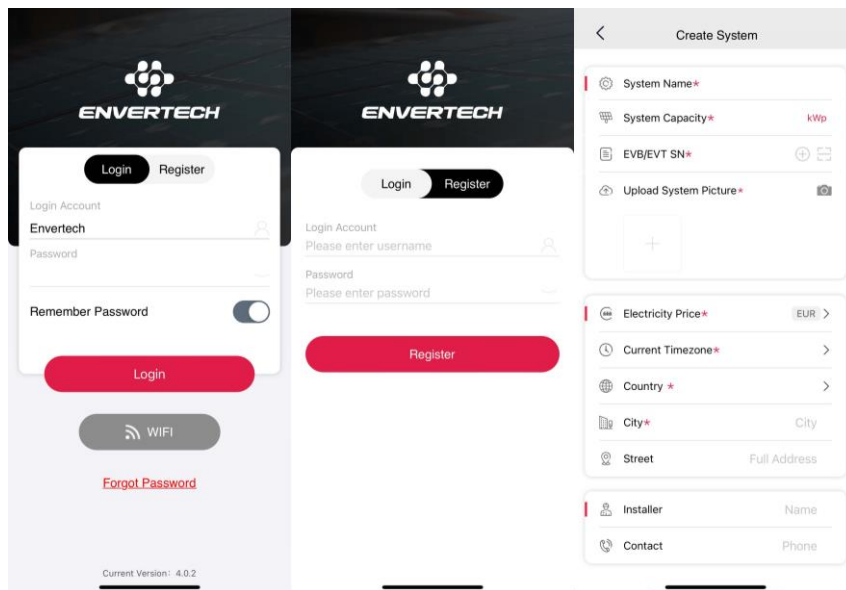

Fields marked with an asterisk (\*) are required.

For Device S/N, you can find S/N labeling on the microinverter or outer packaging. Enter the last 8 digits of it or scan the corresponding barcode.

**2) MI Binding**

**Option 1. Use EnverView app to bind MI**

a. Log in to your account on your mobile phone. Then go to “Settings”.

b. Under “Device Management”, click “+” and enter the SN of the microinverter. Please check the SN to make sure it’s correct.

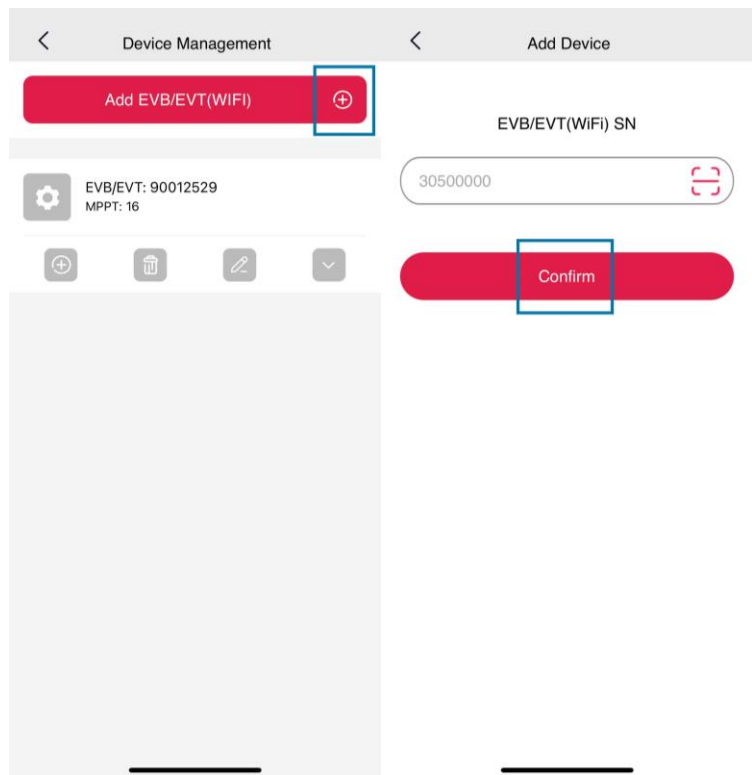

c. Click “Confirm” to finish adding the microinverter.

Note: Please ensure that both the microinverter and your phone are in the same router network.

**Option 2. Use EnverPortal to bind MI**

- a. Login to [www.envertecportal.com](http://www.envertecportal.com) with the newly registered account, and go to Settings-Management.
- b. Click Add, then enter the SN of the microinverter, click OK to finish binding.

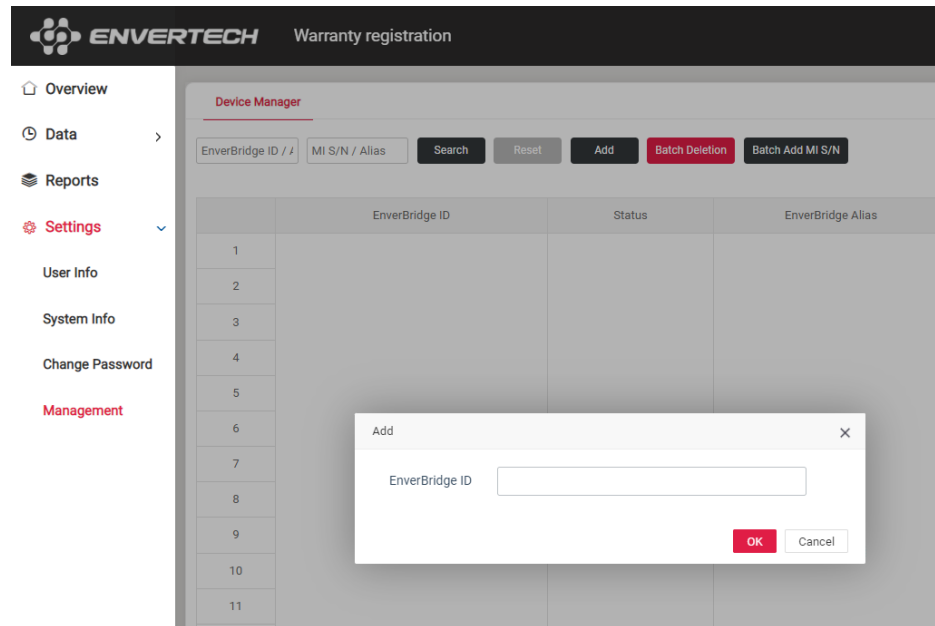

**3) Checking data**

Login to your account to check data.

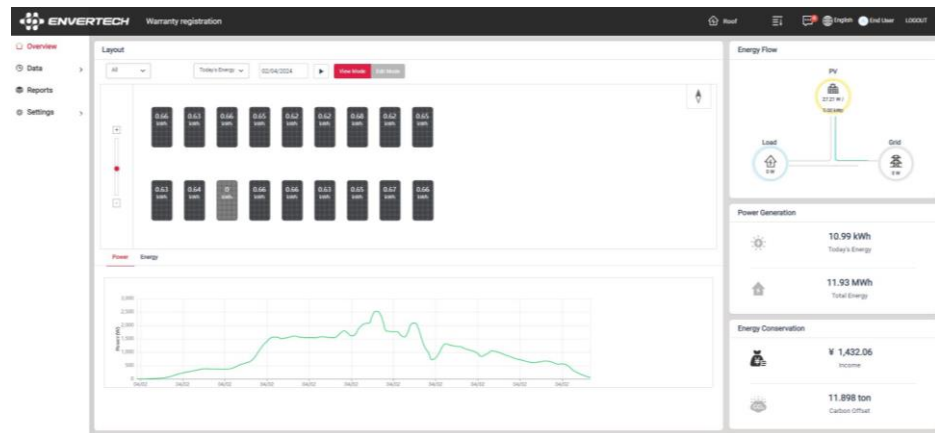

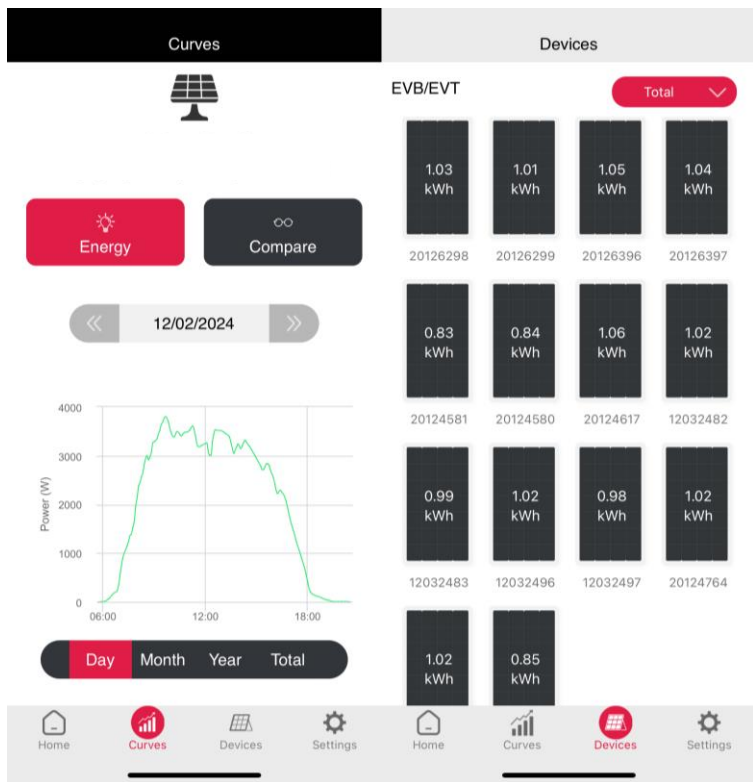

## 6. Debugging and Operating

Please notice the symbols.



### WARNING

Only qualified personnel may connect the Envertech microinverter to the utility grid after receiving prior approval from the electrical utility company.



### WARNING

Ensure that all AC and DC wiring is correct. Ensure that none of the AC and DC wires is twisted or damaged.

### 6.1 Energize the System

1. Turn on the switch or the circuit breaker at each microinverter AC branch.

2. Turn on the main AC circuit breaker in the distribution box. Your system will start to produce power after 3 minutes.

3. Envertech microinverters begin to communicate through the power lines to EnverBridge. The entire system will be detected within 10 minutes.

4. The voltage and frequency of the microinverter can be adjusted on the site. If adjustments are required by your local utility company, installers can use EnverBridge to manage grid parameters after all microinverters have been detected.

### 6.2 Microinverter Operation

The Envertech microinverter is powered on when there is sufficient DC voltage from the PV module. The LED light of each microinverter will blink green to indicate normal start-up operation approximately 1 minute after DC power is applied.

## 7. Troubleshooting and Maintenance

Adhere to all the safety measures described throughout this manual. If the PV system does not operate correctly, the following troubleshooting measures can be applied by qualified personnel.

### WARNING

Do not attempt to repair the Envertech microinverter. It contains no user-serviceable parts. If the microinverter fails, contact your direct supplier or Envertech customer service to obtain an RMA (return merchandise authorization) number and start the replacement process.

### 7.1 LED Status Indications and Error Report

#### LED Startup:

The LED of each microinverter blinks red for a while at the beginning and then blinks green to indicate normal start-up approximately 10 seconds after DC power is applied. If the LED blinks red after DC power is on, it indicates a failure during the start-up.

**Post-Startup LED Indications:**

Check LED status to confirm the present situation.

**Flashing Green:**

It indicates normal operation.

**Flashing Red:**

1. If a red light flashes every 2 or 3 seconds, it indicates that the microinverter is waiting for the sun or preparing to produce energy.
2. If the red light flashes continuously, it indicates that the microinverter is not operating normally. The microinverter does not detect that the utility grid is within operable voltage/frequency range. The microinverter cannot produce power until this is solved.

**7.2 Troubleshoot an Inoperable Microinverter**

To troubleshoot an inoperable microinverter, follow the steps in the order shown below.

**WARNING:** Be aware that only qualified personnel should troubleshoot the PV array or the Envertech microinverter.

**Best Practice:** Please do not disconnect the DC connection while the system is working. Ensure that no current is flowing in the DC wires prior to disconnecting. If necessary, use an opaque to cover the PV module prior to disconnecting the PV module. Always disconnect AC power before disconnecting the PV module from the Envertech microinverter. Disconnecting AC connectors of the microinverters is also a means of cutting off AC power.

**WARNING:** The AC and DC connectors on the cabling are rated as a disconnecting point only when used with an Envertech microinverter.

**WARNING:** Envertech microinverters are powered by DC power from the PV modules. Please disconnect and reconnect DC power to check the LED blinks 1 minute after DC is applied.

1. Make sure AC breakers are on.
2. Check the connection to the utility grid and verify that the grid voltage is within the allowable ranges shown in the Technical Data section.

3. Verify that AC voltage at all solar power circuit breakers of the load centers is within the ranges shown in the following table.
4. Verify that AC line voltage at the junction box for each AC branch circuit is within the ranges required by local grid standards.

Single-Phase 230 VAC		Three-Phase 230 VAC	
L to N	189 to 260VAC	L1 to L2 to L3	310 to 460VAC

5. Confirm if the microinverter side is connected to the grid by measuring the voltage from AC line to line and line to neutral.
6. Visually check if AC branch circuit connection is correctly done. Reinstall if necessary. Check also for damage, such as rodent damage.
7. Make sure that all circuit breakers are off.
8. Disconnect and re-connect the PV modules' DC connectors with microinverters. The LED status of each microinverter will blink green to indicate normal start-up operation soon after DC power is applied (less than one minute).
9. Attach an ammeter clamp to one conducting wire of the DC cables from the PV module to measure the microinverter's current. This will be under 1 Amp if AC is disconnected.
10. Check the DC connection between the microinverter and the PV module. The connection may need to be tightened or reseated. If the connection is worn out or damaged, it needs replacement.
11. Verify with your utility company that grid frequency is within the regulated range.

**7.3 Disconnect Microinverters from PV Modules**

If your problems are still unsolved with the steps above, please contact Envertech tech support through [www.envertec.com](http://www.envertec.com). If Envertech approves the replacement, please take off the microinverter according to the following instructions. In order to ensure the disconnection between the microinverter

and the PV Module will not be done while the microinverter is at working status, please strictly follow the steps below.

1. Turn off the AC branch circuit breaker.
2. Disconnect the microinverters in the following procedure.

Pull the AC connectors of both sides of the microinverters in the opposite direction with appropriate force.

3. Cover the PV module with an opaque, and then disconnect the PV module DC connectors from the microinverter.
4. Loosen the grounding screw and remove the grounding wire.
5. Take off the microinverter from the PV frame.

### 8. System Diagram

#### 1. Single phase

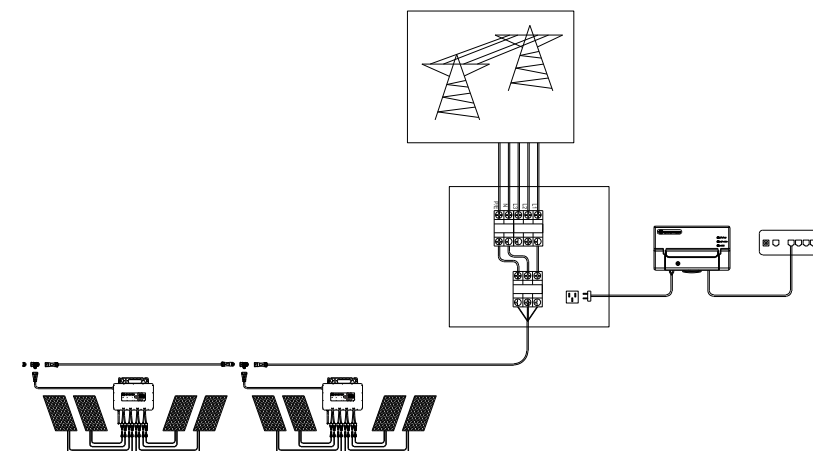
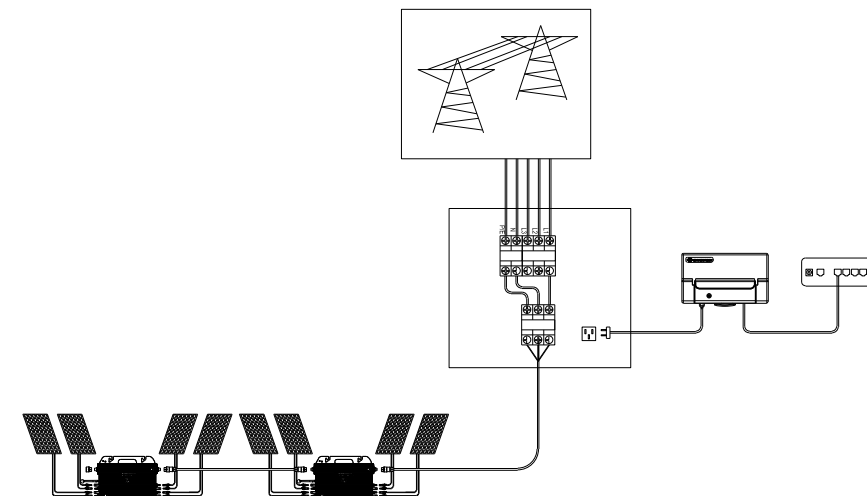
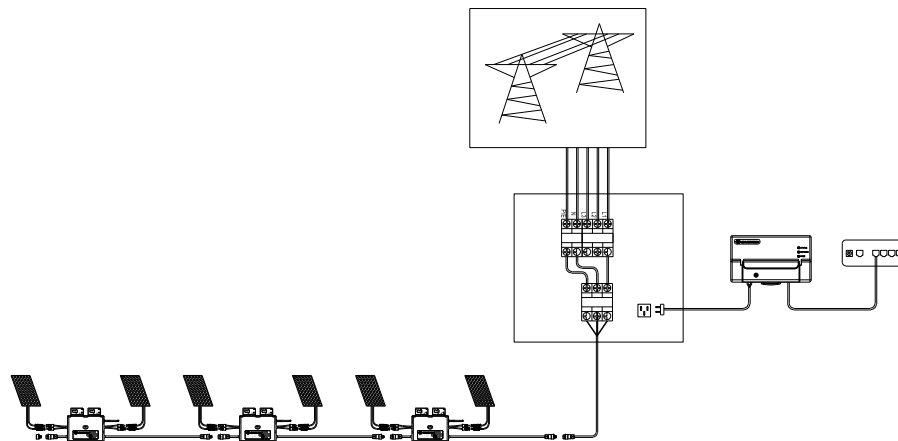
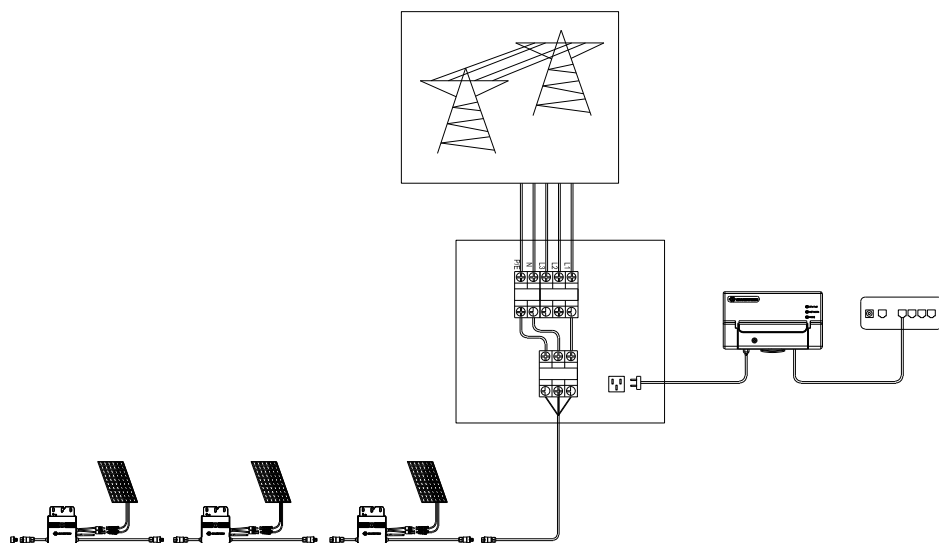



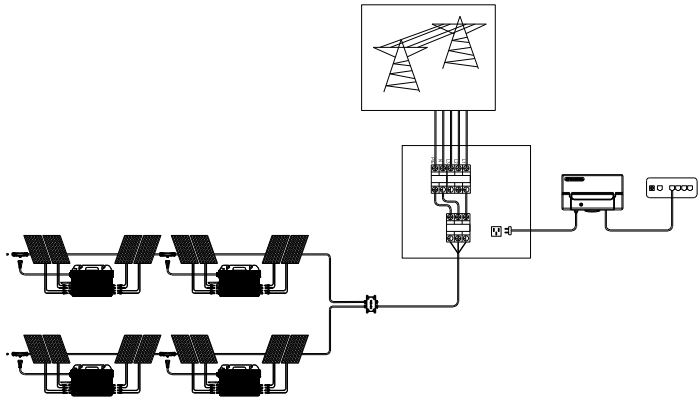

2. Three phase

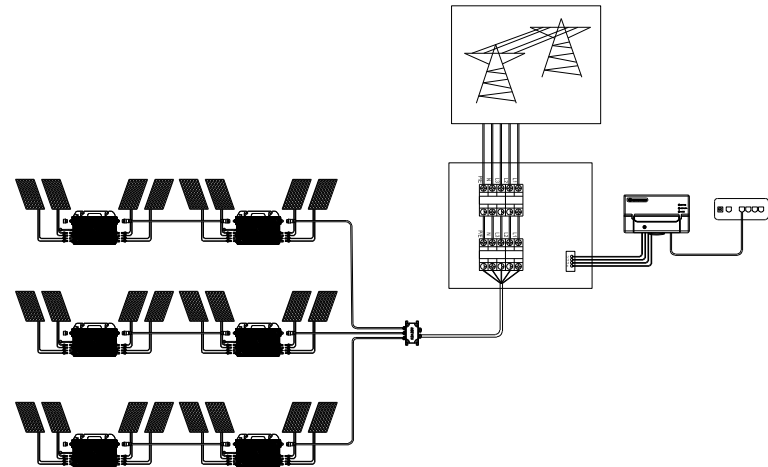
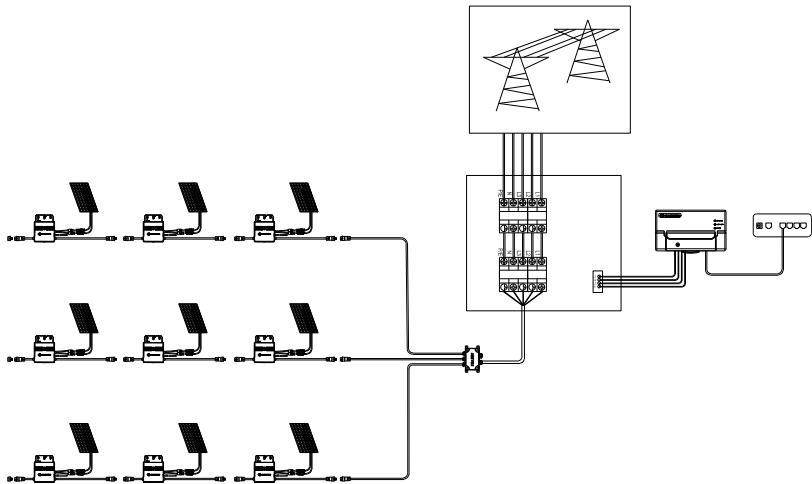
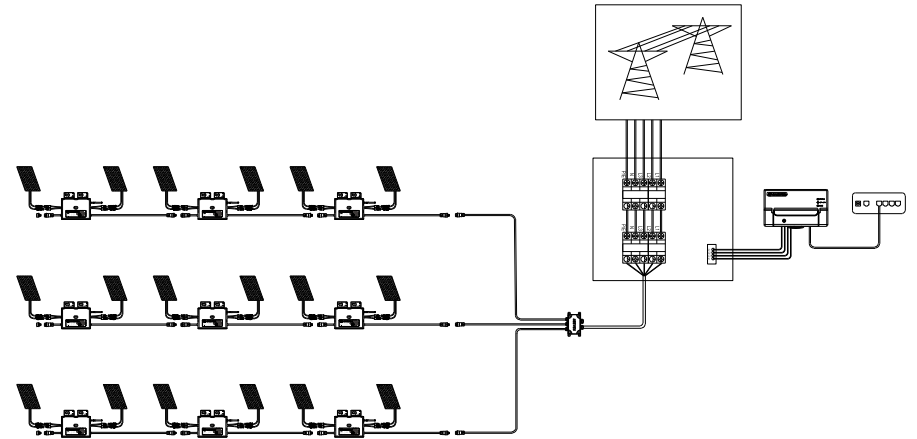

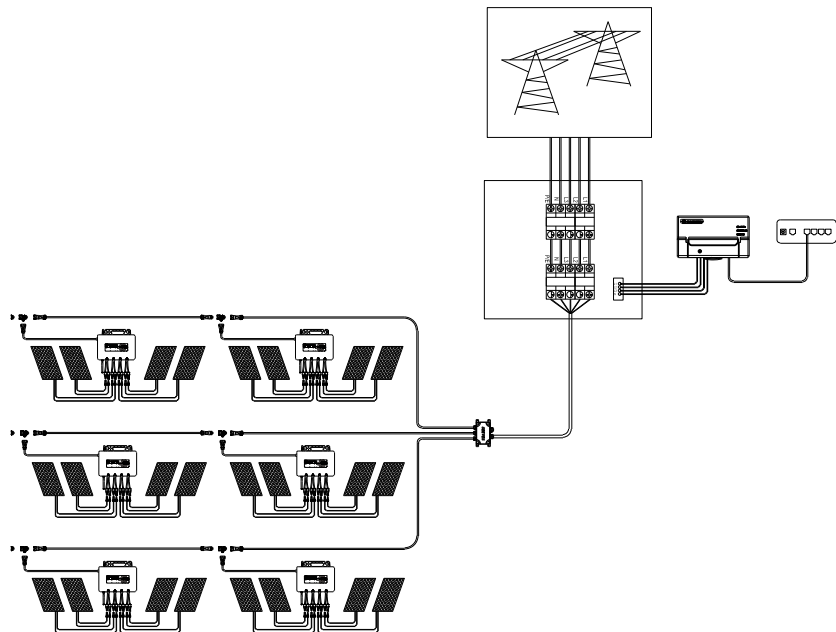

Unscrew the front cover with the complimentary hex screwdriver, then plug wires on each phase into the corresponding connector of EVB300.

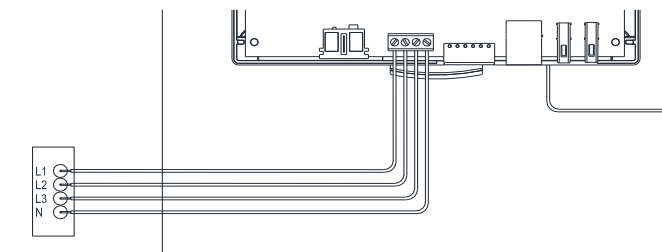

## 9. Recycling and Disposal

In order to comply with the regulations on recycling management of electrical and electronic wastes in various countries, electrical equipment that has reached its lifetime must be collected separately to the unit or individual that has obtained the qualification for disposing discarded electrical and electronic products. For any equipment that you no longer use, please return it to your dealer for recycling, or send it to an approved recycling unit in your area for recycling.



### WARNING:

Do not attempt to repair the Envertech microinverter. It contains no user-serviceable parts. If the microinverter fails, contact your direct supplier or Envertech customer service to obtain an RMA (return merchandise authorization) number and start the replacement process.

## 10. Contact

**Envertech Corporation Ltd.**

Tel: +86 21 6858 0086

Web: [www.envertec.com](http://www.envertec.com)

Email: [info@envertec.com](mailto:info@envertec.com)

Address: No.138, Xinjunhuan road, Minhang District, Shanghai, China